

**IMPORTANT — Please make certain the persons who is using the equipment thoroughly read and understand the user's manual prior to operation**

# **GASOLINE INVERTER GENERATOR**

## **USER'S MANUAL**

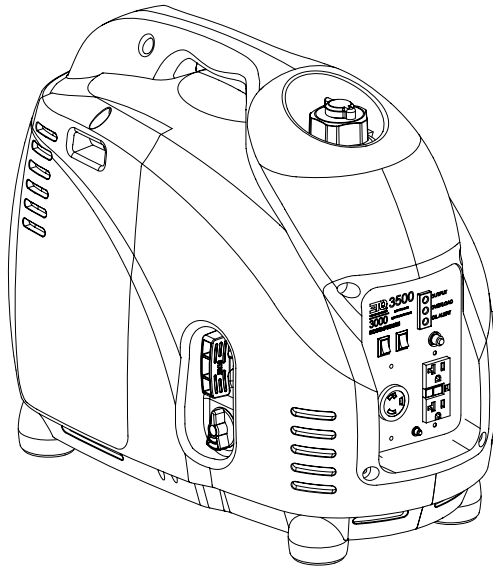

## CONTENTS

1.SAFETY INFORMATION.....	2
2.CONTROL FUNCTION.....	3
3.PRE-OPERATION CHECK.....	5
4.OPERATION.....	6
5.PERIODIC MAINTENANCE.....	9
6.TROUBLE SHOOTING.....	12
7.STORAGE.....	13
9.SPECIFICATIONS.....	14
10.WIRING DIAGRAM.....	15

## ! WARNING

PLEASE READ AND UNDERSTAND THIS MANUAL COMPLETELY BEFORE OPERATING THE MACHINE.

## 1 . SAFETY INFORMATION

### 1 ) EXHAUST FUMES ARE POISONOUS

- Never operate the engine in a closed area because it may cause unconsciousness and death within a short time. Operate the engine in a well ventilated area.

### 2 ) FUEL IS HIGHLY FLAMMABLE AND POISONOUS

- Always turn off the engine when refueling
- Never refuel while smoking or in the vicinity of an open flame.
- Take care not to spill any fuel on the engine or muffler when refueling.
- If you swallow any fuel, inhale fuel vapor, or allow any fuel to get in your eyes, see your doctor immediately. If any fuel spills on your skin or clothing, immediately wash with soap and water and change your clothes.
- When operating or transporting the machine, be sure it is kept upright. If tilted, fuel may leak from the carburetor or fuel tank.

### 3 ) ENGINE AND MUFFLER MAY BE HOT

- Place the machine in a place where pedestrians or children are not likely to touch the machine.
- Avoid placing any flammable materials near the exhaust outlet during operation.
- Keep the machine at least 1 m ( 3 ft ) from buildings or other equipment, or the engine may overheat.
- Avoid operating the engine with a dust cover.
- Be sure to carry the generator only by its handle.
- Put the machine on a flat surface. This will allow the machine to distribute the heat evenly.

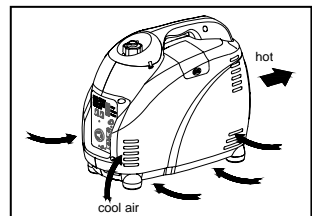

### 4 ) ELECTRIC SHOCK PREVENTION

- Never operate the engine in rain or snow.
- Never touch the machine with wet hands or electrical shock will occur.
- Be sure to ground (earth) the generator.

The National Electric Code requires that the frame of generator and the external electrically conductive parts of the generator be connected to an

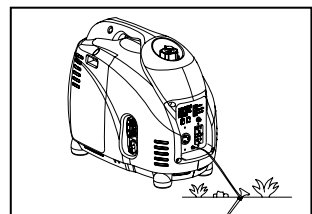

approved earth ground. Local codes may differ and require other grounding specifications. For this purpose, please use the ground wire that attaches from the frame to the generator unit.

Using a No. 12 AWG (American Wire Gauge) stranded copper wire to the frame and to an earth-driven copper or brass grounding rod provides sufficient safety against shock. However, local codes may differ. Contact a local electrician to find out specifications for grounding your generator

## 5 ) CONNECTION NOTES

- Avoid connecting the generator to commercial power outlet.
- Avoid connecting the generator in parallel with any other generator.

## 2 . CONTROL FUNCTION

### DESCRIPTION

- |                               |                           |                             |
|-------------------------------|---------------------------|-----------------------------|
| (1) Engine switch             | (2) Auto throttle         | (3) Fuel tank               |
| (4) Spark plug                | (5) Muffler               | (6) Carrying handle         |
| (7) Choke lever               | (8) AC receptacle L14-30R | (9) Ground (earth) terminal |
| (10) AC receptacle 5-20R GFCI | (11) AC protector 20A     | (12) Oil alert light        |
| (13) Overload light           | (14) Output light         | (15) Fuel filter            |
| (16) Fuel tank cap            | (17) Recoil starter       | (18) Fuel cock              |
| (19) Oil filler cap           | (20) Air filter cover     |                             |

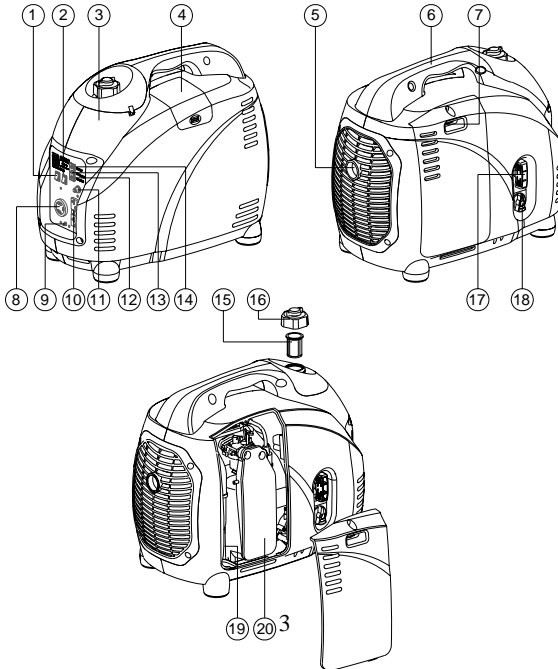

## 1 ) OIL WARNING SYSTEM

When the oil level falls below the low level line, the engine will stop automatically. Unless you refill with oil, the engine will not start again.

## 2 ) ENGINE SWITCH

The engine switch controls the ignition system.

① "ON"

Ignition circuit is switched on. The engine can be started.

② "OFF"

Ignition circuit is switched off. The engine will not run.

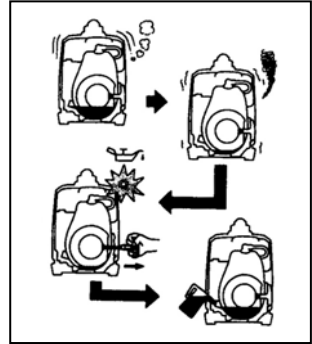

## 3 ) AUTO THROTTLE

When the **AUTO THROTTLE** switch is turned to "ECO", the economy control will adjust the engine speed according to the connected load. The results are better fuel consumption and less noise.

## 4 ) FUEL TANK CAP AIR VENT KNOB

The fuel tank cap is provided with an air vent knob to stop fuel flow. The air vent knob must be turned once counterclockwise from the closed position. This will allow fuel to flow to the carburetor and the engine to run.

When the engine is not in use, tighten the air vent knob clockwise until it is finger-tight to stop fuel flow.

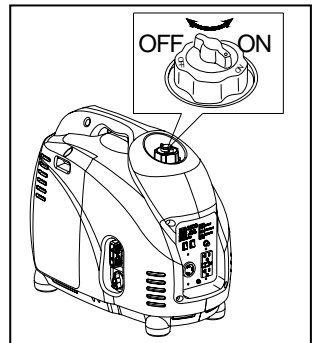
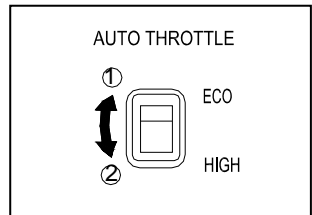
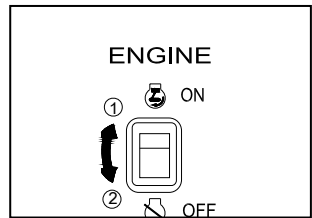

## 5 ) FUEL COCK

The fuel cock is used to supply fuel from the tank to the carburetor.

## 3. PRE-OPERATION CHECK

### NOTE:

- Add more than 2 liters of fuel to run this machine for the first time.
- Pre-operation checks should be made each time the generator is used.

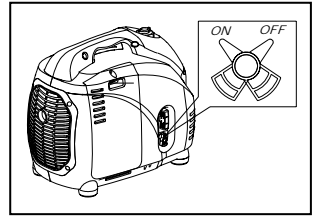

## 1 ) CHECK ENGINE FUEL

- Make sure there is sufficient fuel in the tank.
- If fuel is low, refill with unleaded automotive gasoline.
- Be sure to use the fuel filter screen on the fuel filter neck.
- Recommended fuel: Unleaded gasoline.
- Fuel tank capacity: 5.7 liters

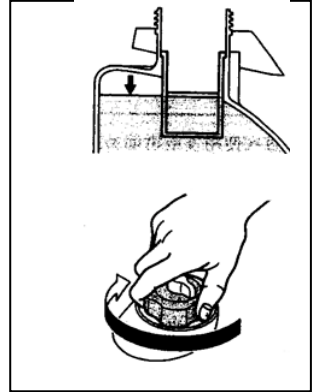

### WARNING:

- Do not refill the generator while the engine is running or hot.
- Close fuel cock before refueling the generator.
- Be careful not to allow dust, dirt, water or foreign objects into the fuel.
- Do not fill above the top of the fuel filter or the fuel may overflow when the fuel heats up and expands.
- Wipe off spill fuel thoroughly before starting engine.
- Keep open flames away.

## 2 ) CHECK ENGINE OIL

Make sure the engine oil is at the upper level of the oil filler hole. Add oil as necessary.

- Remove oil filler cap and check the engine oil level.
- If oil level is below the lower level line, refill with suitable oil to upper level line. Do not screw in the oil filler cap when checking oil level.
- Change oil if contaminated.

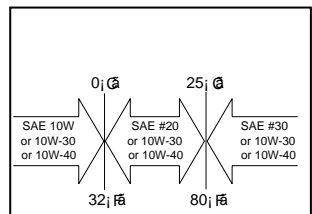
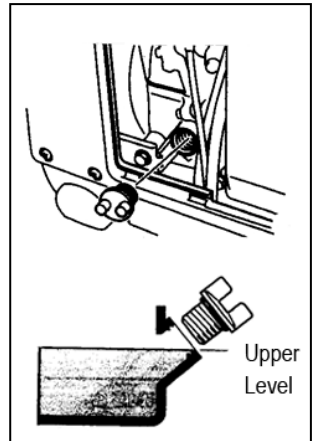

- Oil capacity: 0.9 liters
- Recommended engine oil:  
Above SJ Grade

### 3 ) GROUND (Earth)

Make sure to ground (earth) the generator.

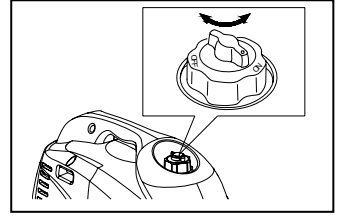

## 4. OPERATION

**NOTE:** -----

- The generator has been shipped without engine oil. Fill with oil or it will not start.
- 

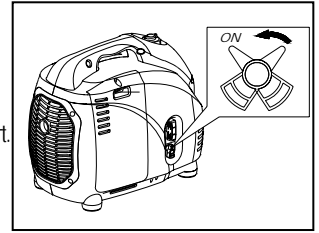

### 1 ) STARTING THE ENGINE

**NOTE:** -----

- Before starting the engine, do not connect electrical loads.
  - Turn the economy control switch to the "OFF" position.
- 

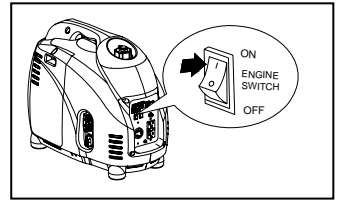

1. Open the fuel tank air vent to the "ON" position.
2. Turn the fuel cock lever to the "ON" position.
3. Turn the engine switch to the "ON" position
4. Turn the choke lever to the " | | " position. Not necessary if the engine is warm.

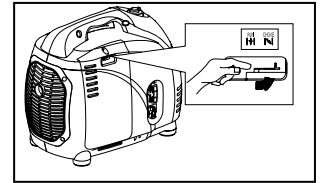

5. Pull the starter handle slowly until resistance is felt. This is the "Compression" point. Return the handle to its original position and pull swiftly. Do not fully pull out the rope. After starting, guide the starter handle to its original position while still holding the handle. Grasp the carrying handle firmly to prevent the generator from falling over when pulling the recoil starter.
6. Warm up the engine.
7. Turn the choke lever back to the operating position.
8. Warm up the engine without a load for a few minutes.

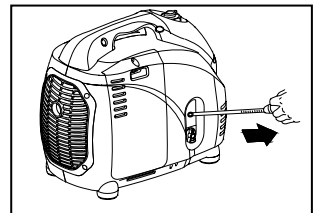

### 2 ) USING ELECTRIC POWER

#### 1. AC APPLICATION

- (a) Check the AC pilot lamp for proper voltage.
- (b) Turn the economy control switch to the "ON" position.
- (c) Turn off the switch(es) of the electrical appliance(s) before connecting to the generator.
- (d) Insert the plug(s) of the electrical appliance(s) into the receptacle(s).

**CAUTION:** -----

- Be sure the electrical load is turned off before plugging it in.
  - Be sure the total load is within the generator rated output.
  - Be sure the socket load current is within socket rated current.
  - The **AUTO THROTTLE** switch must be turned to "HIGH" when using electric devices that require a large starting current, such as a compressor or a submersible pump.
- 

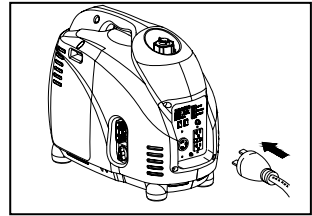
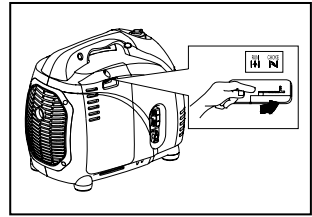

## 2 . OVERLOAD INDICATOR LIGHT

The overload indicator light comes on when an overload of a connected electrical device is detected, the inverter unit overheats, or the AC output voltage rises. The electronic breaker will then activate, stopping power to the generation in order to protect the generator and any connected electric devices. The AC pilot light (green) will turn off and the overload indicator light (red) will turn on, but the engine will not stop running. As the engine overloads the overload indicator light (red) will turn on. Allowing you to turn off the power too appliances. After twenty seconds the overload indicator light will turn off and the generator will begin to run again. If the generator is still overloaded the overload indicator light will turn on once again. If this process happens a total of three times the engine will completely turn off. If so please follow the following steps

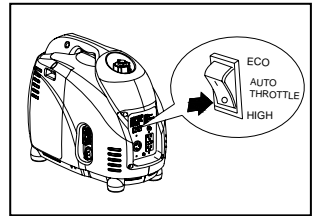

- (a) Turn off any connected electric devices and stop the engine
- (b) Reduce the total wattage of connected electric devices within the application range.
- (c) Check for blockages in the cooling air inlet and around the control unit. If any blockages are found, remove.
- (d) After checking, restart the engine.

**CAUTION:** -----

- The generator AC output automatically resets when the engine is stopped and then restarted.



- The overload indicator light may come on for a few seconds at first when using electric devices that require a large starting current, such as a compressor or a submergible pump. However, this is not a malfunction.
- 

### 3 ) STOPPING THE ENGINE

1. Turn off the power switch(s) on electrical loads or disconnect any electric devices.
2. Turn the engine switch to "OFF" position.
3. Turn the fuel cock lever to "OFF".
4. Turn the fuel tank cap air vent knob clockwise until it is finger-tight.

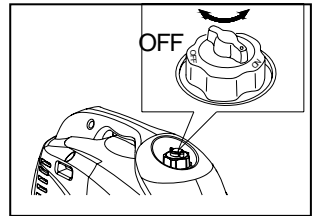
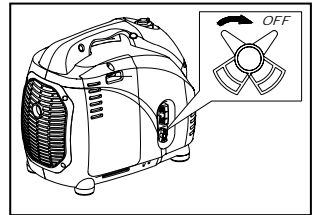
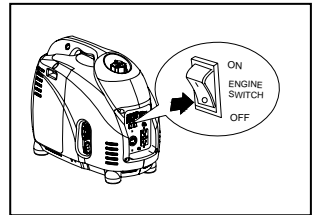
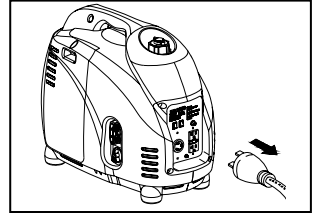

## 5. PERIODIC MAINTENANCE

### 1) MAINTENANCE CHART

Regular maintenance is most important for the best performance and safe operation.

Item	Remarks	Pre-operation check (daily)	Initial 1 months or 20 Hr	Every 3 months or 50Hr	Every 6 months or100Hr	Every 12 months or 300Hr
Spark Plug	Check condition, adjust gap and clean. Replace if necessary.			●		
Engine Oil	Check oil level	●				
	Replace		●		●	
Oil filter	Clean oil filter				●	
Air Filter	Clean. Replace if necessary.			●		
Fuel Filter	Clean fuel cock filter. Replace if necessary				●	
Choke	Check choke operation	●				
Valve Clearance	Check and adjust when engine is cold.					●
Fuel Line	Check fuel hose for cracks or damage. Replace if necessary.	●				
Exhaust System	Check for leakage. Retighten or replace gasket if necessary	●				
	Check muffler screen. Clean / replace if necessary.					●
Carburetor	Check choke operation	●				
Cooling system	Check fan damage.					●
Starting system	Check recoil starter operation.	●				
Idle speed	Check and adjust engine idle speed					●
Fittings / Fasteners	Check all fittings and fasteners correct if necessary.				●	
Crankcase breather	Check breather hose for cracks or damage. Replace if necessary					●
Generator	Check the pilot lights	●				

## 2 ) ENGINE OIL REPLACEMENT

Place the machine on a level surface and warm up the engine for several minutes. Then stop the engine and turn the fuel cock knob to "OFF". Turn the fuel tank cap air vent knob clockwise.

1. Loosen the screw and remove the cover.
  2. Remove the oil filler cap
  3. Place an oil pan under the engine. Tilt the generator to drain the oil completely
  4. Replace the generator on a level surface.
  5. Add engine oil to the upper level.
  6. Install the oil filler cap
  7. Install the cover and tighten the screw
- Recommended engine oil: (*see page 5*)

Above SJ Grade

### CAUTION: -----

- Be sure no foreign material enters the crankcase.
- Do not tilt the generator when adding engine oil. This could result in overfilling and damage to the engine
- Clean the oil filter every 100hr.

## 3 ) AIR FILTER

Maintaining the air filter in proper condition is very important. Dirt induced through improper installation or improperly servicing the air filter will wear out the engine. Keep the air filter element always clean.

1. Remove the cover.
2. Remove the air filter cover and element.
3. Wash the element in solvent and dry.
4. Oil the element and squeeze out excess oil. The element should be wet but not dripping.
5. Insert the element into the air filter.
6. Install the cover

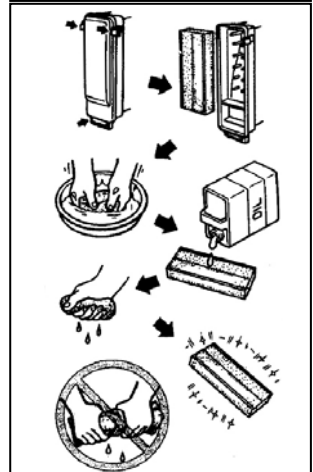
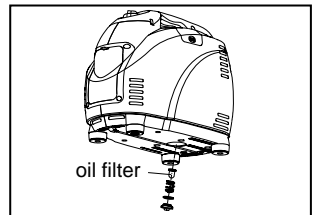
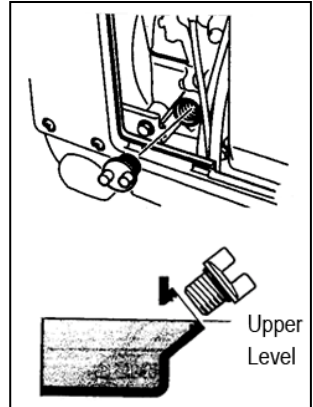
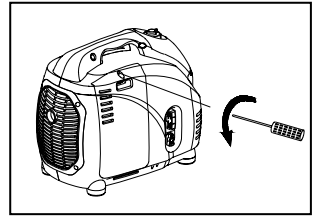

**CAUTION:** -----

The engine should never run without the element; excessive piston and/or cylinder wear may result.

-----

**4 ) CLEANING AND ADJUSTING SPARK PLUG**

1. Remove the cover.
2. Check for discoloration and remove the carbon.
3. Check the spark plug type and gap.
4. Install the spark plug.
5. Install the cover

Standard electrode color: Tan Color  
Standard Spark Plug: CR4HSB (NGK)  
Spark Plug Gap: 0.6-0.7 mm (0.024-0.028 in)

**5 ) FUEL TANK FILTER**

1. Remove the fuel tank cap and filter.
2. Clean the filter with solvent. If damaged, replace.
3. Wipe the filter and insert it.

**!WARNING** -----

- Be sure the tank cap is tightened securely.
- 

**6 ) MUFFLER SCREEN**

**!WARNING** -----

- The engine and muffler will be very hot after the engine has been running.
- Avoid touching the engine and muffler while they are still hot with any part of your body or clothing during inspection or repair.

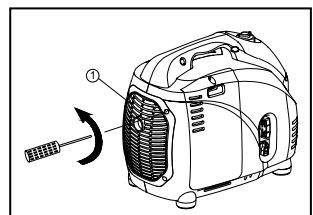
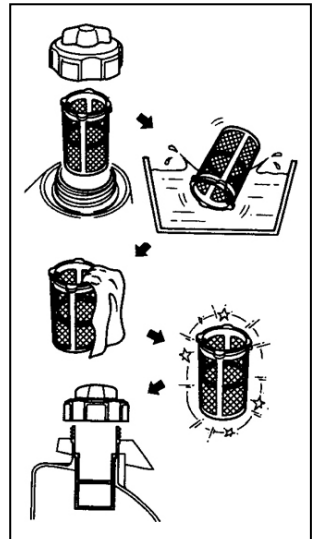
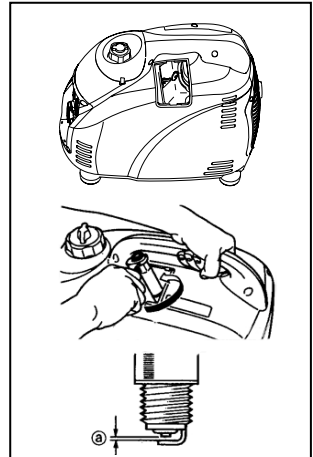

- 
1. Remove the cover.
  2. Remove the muffler screen.
  3. Use a flathead screw driver to pry the spark arrester out from the muffler
  4. Remove the carbon deposits on the muffler screen and spark arrester using a wire brush.
  5. Install the muffler screen.
  6. Install the cover

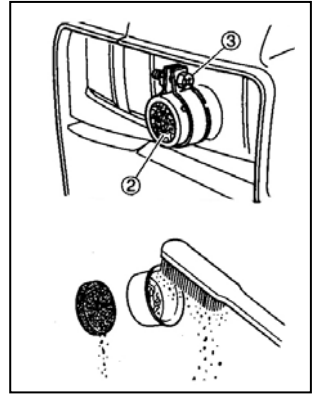

## 6 . TROUBLE SHOOTING

### 1 ) Engine will not start

#### 1. Fuel system

No fuel supplied to the combustion chamber.

- No fuel in tank...Supply fuel.
- Fuel in tank...Fuel tank cap air vent knob to "ON", fuel cock knob to "ON".
- Clogged fuel line...Clean fuel line.
- Clogged carburetor...Clean carburetor.

#### 2 . Engine oil system

Insufficient

- Oil level is low...Add engine oil.

#### 3. Electrical systems

Poor spark

- Spark plug is dirty with carbon deposit or it may be wet...Remove carbon or wipe the spark plug dry.
- Faulty ignition system...Consult dealer.

#### 4. Compression is insufficient

- Worn out piston and cylinder...Consult dealer.

### 2 ) Generator won't produce power

Safety device (AC) to "OFF" ...Stop the engine, then restart.

Safety device (DC) to "OFF" ...Press to reset protector button.

## **7. STORAGE**

Long term storage of your machine will require some preventive procedures to guard against deterioration.

### **1 ) DRAIN THE FUEL**

1. Remove the fuel tank cap, drain the fuel from the fuel tank
2. Remove the cover, drain the fuel from the carburetor by loosening the drain screw.

### **2 ) ENGINE**

1. Remove the spark plug, pour in about one tablespoon of SAE 10W30 or 20W40 motor oil into the spark plug hole and reinstall the spark plug.
2. Use the recoil starter to turn the engine over several times (with ignition off).
3. pull the recoil starter until you feel compression.
4. Stop pulling.
5. Clean exterior of the generator and apply a rust inhibitor.
6. Store the generator in a dry, well-ventilated place, with a cover placed over it.
7. The generator must remain in a vertical position.

## 9. SPECIFICATION

MODEL		IN3500i
GENERATOR	Type	Inverter Generator
	AC Voltage	120V
	Frequency	60Hz
	Max. Output	3500 Watts
	Rated Output	3000 Watts
	Power Factor	1.0
ENGINE	Model	XY157F
	Type	Air-cooled, 4 cycle, OHV, Gasoline Engine
	Bore×Stroke mm×mm	57×57.8
	Displacement	147.5 cc
	Max. Output	4.0KW / 5500rpm
	Fuel	Regular Automobile Gasoline
	Fuel tank Capacity	5.7 liters
	Rated Continuous Operation	3h5min ( 100% Load ) 4h10min ( 50% Load )
	Lubricating oil	SAE 10W30
	Lubricating oil Capacity	0.90 liter
	Starting System	Recoil Starter
	Ignition system	T.C. I.
	Spark Plug: Type	A7RTC or CR5HSB (NGK)
DIMENSION	Net dimension L×W×H	565×320×470
	Overall dimension L×W×H	595×355×510
	Net Weight	29 Kg
	Dry Weight	31 Kg

- Specifications subject to change without prior notice.

# 10 . WIRING DIAGRAM

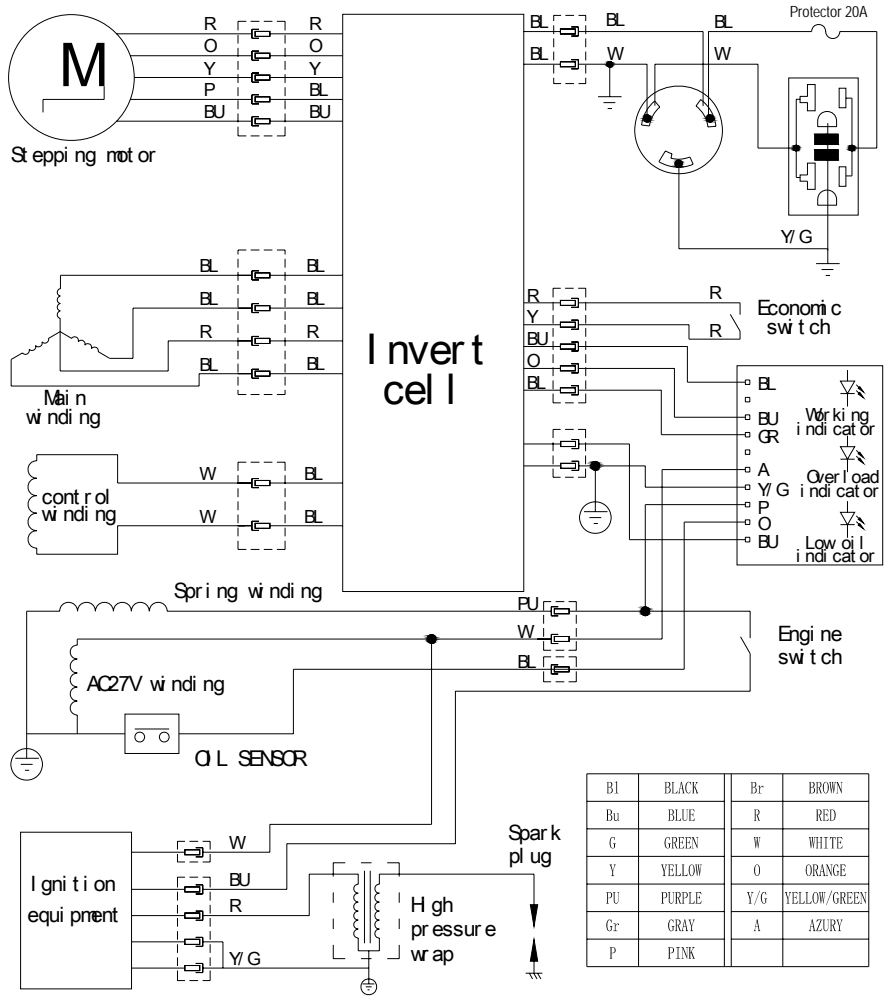



## LIMITED WARRANTY

Eastern Tools & Equipment, Inc. will repair or replace, free of charge, any part or parts of the generator that are defective in material or workmanship or both. Transportation charges on parts submitted for repair or replacement under this Warranty must be borne by purchaser. This warranty is effective for the time period and subject to the conditions provided for in this policy. For warranty service, find the nearest Authorized Service Dealer by contacting the place of purchase or Eastern Tools & Equipment, Inc. THERE IS NO OTHER EXPRESSED WARRANTY. IMPLIED WARRANTIES, INCLUDING THOSE OF MERCHANTABILITY AND FITNESS FOR A PARTICULAR PURPOSE, ARE LIMITED TO ONE YEAR FROM PURCHASE, OR TO THE EXTENT PERMITTED BY LAW ANY AND ALL IMPLIED WARRANTIES ARE EXCLUDED. LIABILITY FOR CONSEQUENTIAL DAMAGES UNDER ANY AND ALL WARRANTIES ARE EXCLUDED TO THE EXTENT EXCLUSION IS PERMITTED BY LAW. Some states do not allow limitations on how long an implied warranty lasts, and some states do not allow the exclusion or limitation of incidental or consequential damages, so the above limitation and exclusion may not apply to you. This warranty gives you specific legal rights and you may also have other rights, which vary from state to state.

Eastern Tools & Equipment, Inc

### WARRANTY PERIOD\*\*\*

ENGINES	WITHIN U.S.A AND CANADA		OUTSIDE U.S.A. AND CANADA	
	CONSUMER USE	COMMERCIAL USE	CONSUMER USE	COMMERCIAL USE
GASOLINE GENERATOR	1 year	90 days	1 year	90 days

The warranty period begins on the date of purchase by the first retail consumer or commercial end user, and continues for the period of time stated in the table above. "Consumer use" means personal residential household use by a retail consumer. "Commercial use" means all other uses, including the commercial, income producing or rental purpose. Once the engine has experienced commercial use, it shall thereafter be considered as a commercial use engine for purpose of this warranty. Engines use in competitive racing or commercial or rental tracks are not warranted.

**\*\*\*A two-year warranty applies to the emission control system on engines certified by EPA and CARB.**

**IMPORTANT**

**“WARRANTY REGISTRATIONS IS NECESSARY TO OBTAIN LIMITED WARRANTY ON EASTERN TOOLS & EQUIPMENT, INC., ENGINES. THE WARRANTY REGISTRATION CARD MUST BE RETURNED WITHIN 15 DAYS OF PURCHASE FOR LIMITED WARRANTY TO BE VALID”**

*About Your Product Warranty*

Eastern Tools & Equipment, Inc. welcomes warranty repair and apologizes to you for being inconvenienced. Any Authorized Service Dealer may perform warranty repairs. Most warranty repairs are handled routinely, but sometimes warranty service may be inappropriate. For example, warranty would not apply if an engine is damaged because of misuse, lack of routine maintenance, shipping, handling, warehousing and improper installation. Similarly, warranty is void if the serial number on the engine has been removed or if the engine has been altered or modified. If a customer differs with the decision of the Service Dealer, an investigation will be made to determine whether the warranty applies. Ask the Service Dealer to submit all supporting facts to his Distributor or the factory for review. If the distributor or the factory decides that the claim is justified, the customer will be fully reimbursed for those items that are defective. To avoid misunderstanding, which might occur between the customer and the dealer, listed below are some of the causes of engine failure that the warranty does not cover.

**Normal wear:**

Engines and generators, like all mechanical devices, need periodic parts service and replacement to perform well. Warranty will not cover repair when normal use has exhausted the life of a part of an engine.

**Improper maintenance:**

The life of an engine or your equipment depends upon the conditions under which it operates, and the care it receives. Some applications, such as tillers, pumps, and rotary mowers, are very often used in dusty or dirty conditions, which can cause what appears to be premature wear. Such wear, when caused by dirt, dust, spark plug cleaning grit, or other abrasive material that has entered the engine because of improper maintenance is not covered by warranty.

**This warranty cover engine related defective material and/or workmanship only, and not replacement or refund of the equipment to which the engine may be mounted. Nor des the warranty extend to repairs required because of:**

1. Problems caused by parts that are not original eastern tools & equipment, inc., parts.
2. Equipment controls or installations that prevent starting, cause unsatisfactory engine performance, or shorten engine life. (Contact equipment manufacturer.)

3. Leaking carburetor, clogged fuel pipes, sticking valves, or other damage, caused by using contaminated or stale fuel. (Use clean, fresh, lead-free gasoline.)
4. Parts which are scored or broken because an engine was operated with insufficient or contaminated lubricating oil, or and incorrect grad of lubricating oil (check oil level daily or after every 8 hours of operation. Refill when necessary and change at recommended intervals.) Engine damage may occur if oil level is not properly maintained. Read Operating & Maintenance Instructions.
5. Repair or adjustment of associated parts or assemblies such as clutches, transmissions, remote controls, etc., which are not manufactured by Eastern Tools & Equipment, Inc.
6. Damage or wear to parts caused by dirt, which entered the engine because of improper air filter maintenance, re-assembly, or use of a non-original air filter element or cartridge. Read Operating & Maintenance Instructions.
7. Parts damaged by over-speeding, or overheating caused by grass, debris, or dirt, which plugs or clogs the cooling fins, or flywheel are, or damaged caused by operating the engine in a confined area without sufficient ventilation.
8. Engine or equipment parts broken by excessive vibration caused by a loosen cutter blades unbalanced blades or loose unbalanced impellers, improper attachment of equipment to engine crankshaft, over speeding or other abuse in operation.
9. A bent or broken crankshaft, caused by striking a solid object with the cutter blade of a rotary lawn mower, or excessive v-belt tightness.
10. Routine tune-up or adjustment of the engine.
11. Engine or engine component failure, i.e., combustion chamber, valves, valve seats, valve guides, or burned starter motor winding, caused by the alternated fuels such as, liquefied petroleum, natural gas, altered gasoline's etc.

Warranty is available only through service dealers, which have been authorized by Eastern Tools & Equipment, Inc., please contact the place of purchase or Eastern Tools & Equipment, Inc. for a Service Dealer near you.

#### **CALIFORNIA & USEPA EMISSION (OR EVAPORATIVE) CONTROL WARRANTY**

The U.S. Environmental Protection Agency (EPA), the California Air Resources Board (CARB) and Eastern Tools & Equipment, Inc. are pleased to explain the Federal and California Emission Control System Warranty on your small non-road engine. In California, new small nonroad engines must be designed, built and equipped to meet the State's stringent and anti-smog standards. Eastern Tools & Equipment, Inc. must warrant the emission (or evaporative) control system on your small nonroad engine for the periods of time listed above listed above provided there has been no abuse, neglect or improper maintenance of your small nonroad engine.

Your emission (or evaporative) control system may include parts such as the carburetor, or fuel-injection system, the ignition system and catalytic converter. Also included may be hoses, belts, connectors and other emission (or evaporative)-related assemblies.

Where a warrantable condition exists, Eastern Tools & Equipment, Inc. will repair your small nonroad engine at no cost to you including diagnosis, parts and labor.

## OWNER'S WARRANTY RESPONSIBILITIES

As the small nonroad engine owner, you are responsible for the performance of the required maintenance listed in your Owner's Manual. Eastern Tools & Equipment, Inc. recommends that you retain all receipts covering maintenance on your small nonroad engine, but Eastern Tools & Equipment, Inc. cannot deny warranty solely for the lack of receipts or for your failure to ensure the performance of all scheduled maintenance.

As the small nonroad engine owner, you should, however, be aware that Eastern Tools & Equipment, Inc. may deny you warranty coverage if your small nonroad or part thereof has failed due to abuse, neglect, improper maintenance or unapproved modifications.

You are responsible for presenting your small nonroad engine to Eastern Tools & Equipment, Inc. distribution center as soon as a problem exists. The warranty repairs should be completed in a reasonable amount of time, not to exceed 30 days.

If you have any questions regarding your warranty rights and responsibilities or request warranty service you should contact either the place of purchase or Eastern Tools & Equipment, Inc., c/o Service Manager, Engine and Equipment Service Division.

### **IMPORTANT NOTE:**

This warranty statement explains your rights and obligations under Emission Control system Warranty (ECS Warranty), which is provided to our by Eastern Tools & Equipment, Inc. pursuant to California law. Eastern Tools & Equipment, Inc. also provides to original purchasers of new Eastern Tools & Equipment, Inc. engines. Eastern Tools & Equipment, Inc. Limited Warranties for New engines & other Equipment associated with the engine (Eastern Tools & Equipment, Inc. Products Warranty), which is enclosed with all New Eastern Tools & Equipment, Inc. engines and products on a separate sheet. The ECS Warranty applies only to the emission (or evaporative) control system of your new engine. To the extent that there is any conflict in terms between the ECS Warranty and the Eastern Tools & Equipment, Inc., Warranty, the ECS Warranty shall apply except in any circumstances in which the Eastern Tools & Equipment, Inc. Product Warranty may provide a longer warranty period. Both the ECS Warranty and the Eastern Tools & Equipment, Inc. product Warranty describe important right and obligations with respect to your new engine.

Eastern Tools & Equipment, Inc. at its location in Ontario, California can perform warranty service or any authorized service dealer near you. At the time of requesting warranty service, evidence must be presented of the date of sale to the original purchaser. The purchaser shall pay any charges for transporting the product to and from the place when the inspection and/or warranty performed. The purchaser shall be responsible for any damage or loss incurred in connection with the transportation of any engine or any part(s) thereof submitted for inspection and/or warranty work.

If you have any questions regarding your warranty rights and responsibilities, you should contact Eastern Tools & Equipment, Inc.

**PRODUCT REGISTRATION**

For more efficient customer service, please fill out the information below and mail to Eastern Tools & Equipment, Inc. Product Warranty and Registration Division.

Model No. \_\_\_\_\_ Engine Serial No. \_\_\_\_\_ Purchase Date \_\_\_\_/\_\_\_\_/\_\_\_\_

**Purchased from:**

Retail Location  Private Consumer  Other \_\_\_\_\_

Name \_\_\_\_\_

Location Address \_\_\_\_\_

Telephone (\_\_\_\_) \_\_\_\_-\_\_\_\_ Purchase Price \_\_\_\_\_

Purchased:  New  Used

**Consumer Information:**

Name \_\_\_\_\_ Telephone (\_\_\_\_) \_\_\_\_ - \_\_\_\_\_

Street Address \_\_\_\_\_ Suite or Apt No. \_\_\_\_\_

City \_\_\_\_\_ State \_\_\_\_\_ Zip Code \_\_\_\_\_

Province or County \_\_\_\_\_

Are you a:  Business  Residence

**Product Usage Information:**

How often will you use this product?

Everyday  Periodically  Emergency Use Only  Other

**What type of application will you use this product in?**

Heavy Commercial  Moderate Commercial  Light Commercial  Tradeshows

Heavy Residential  Moderate Residential  Light Residential  Camping/Backpacking

Other \_\_\_\_\_

**Important information:**

It is critical to your warranty that the original point of sales receipt be retained by current consumer, and in order to comply with Eastern Tools & Equipment Product Warranty statement you must return the registration card within 15 days of original purchase. Product warranty is valid from original date of purchase.

Please mail the above card to: **Eastern Tools & Equipment, Inc.**  
**111 Bluegrass Dr.**  
**Norwalk, OH 44857**

Mail: *Eastern Tools & Equipment, Inc.*  
*111 Bluegrass Dr.*  
*Norwalk, OH 44857*

Telephone: 1-888-908-6200

Website: www.eastertools.com

